Chapter 1

General Provisions

Article 1.1

INTRODUCTION

1.1.1 History and Regional Setting. The City was settled in 1835, when Thomas and Sally Matteson arrived in what is now Genoa on May 18. Genoa served as a stagecoach stop on the trail to Galena and was incorporated as a City in 1911. During its early history, Genoa flourished as an agricultural community, but has enjoyed a wide variety of small industry through the years. The early 1900's saw the Thompson Piano Company come and go, along with diverse manufacturing establishments, including the Practical Automobile Company. A new major industry sprouted in the community, Eureka Electric Company, which began in 1903 and evolved into Leich Electric, then became A G Communication Systems, and is now occupied by Custom Aluminum Corporation. Greenlee Tool Company began operations in 1948 and continues to be a major employer today.

The City of Genoa is located in DeKalb County, Illinois approximately 60 miles west of Chicago and 20 miles west of the Fox River Valley communities of Elgin, St. Charles, and West Dundee. The City is also within 15 miles of the City of Belvidere, and the City of Marengo.

Genoa lies 7 miles north of the City of Sycamore, the DeKalb County Seat and 12 miles north of the City of DeKalb, the largest City in the County and the location of Northern Illinois University. Northern Illinois University is the second largest institution in the state's university system. The City of Genoa contributes to and benefits from the employment, cultural, and athletic opportunities associated with the university.

The three cities of DeKalb, Sycamore, and Genoa are situated along the primary north-south thoroughfare in the county, Illinois Route 23. Together, these three communities comprise the bulk of the population in DeKalb County (1990 combined population – 47,716), and serve a trade area of approximately 70,000 in the region including portions of Kane, McHenry, Boone and Ogle counties.

1.1.2 The Need for this Ordinance. This Ordinance is intended to serve as a guide for preserving and perpetuating the unique character of Genoa. It addresses various topics regarding the development and use of land in Genoa.

The existing patterns of urban development have seriously eroded the quality of life and economic vitality of cities and villages. The practices of segregating land use and relying upon auto-dependent design criteria have resulted in widespread loss of open space; increased traffic congestion and air pollution; environmental degradation; increases housing and infrastructure costs; inadequate provision of schools, recreation and other public services; and growing areas of crime, poverty and declining property values. The resultant loss of community identity adds to these problems by discouraging citizen awareness of, and participation in, community affairs and the withdrawal of individuals from the social life of the community.

The purpose of this Unified Development Ordinance is not merely to provide minimum regulations necessary to facilitate safe and orderly growth, but to also ensure that growth is an integral part of

the community and contributes to the formation of functional neighborhoods and town centers; increases collective security and community identity to promote civic awareness and responsibility; and, enhances the quality of life for the entire City to ensure the greatest possible economic and social benefits for all Genoa residents and merchants.

To these ends, the Unified Development Ordinance, and related maps, illustrations and diagrams have been prepared with due consideration of future growth; the promotion of a coherent neighborhood-scaled built environment which respects local and regional architecture; the promotion of an integrated and balanced transportation system based on pedestrian, transit and automobile use; the adequate provision of water and sewer infrastructure, schools, parks, and other public necessities; and, for the preservation and enhancement of the natural environment through the protection and restoration of forests, wetlands and prairies by landscaping the public realm.

The justification for this approach taken by this Ordinance is derived from the general dissatisfaction with evidenced from existing urban areas which have grown largely under the prevailing model of development and evidenced during development of the Genoa Comprehensive Plan. Low density development increases the cost of living in order to finance, maintain, and replace infrastructure. Auto dependent design standards increase paved surface areas which in turn increase water run-off, soil erosion, and water supply contamination. Low densities and increased paved surfaces also deplete urban forest cover, decrease property values, and increase traffic congestion, noise, and pollution.

Under this model a majority of a municipality's time and money is spent replacing and extending infrastructure and mitigating the negative impacts of development. Assessed on a project by project basis the total effects and subsequent costs are hidden by immediate tax base increases and owner profits. However, if assessed at the community level over the long term, all additional development conforming to the model described above becomes a burden on the community, and eventually the increased cost of building and living in such areas prevents growth from continuing. This occurs long before an area reaches full economic potential and physical build out. A development model which addresses these problems must treat a community as a highly complex organism, not merely as a collection of individual market segments to exploit, or an opportunity for real estate speculation. The intent of this Ordinance is to avoid these problems by careful planning of the physical design of the City.

1.1.3. General Development Objectives. The objective of the Unified Development Ordinance is to carry out and achieve the goals and objectives of the Genoa Comprehensive Plan. The principal and over riding goal of the Comprehensive Plan is to create and sustain traditional forms of neighborhood development. The Plan and this Ordinance recognize the variety of land development forms, such as countryside, suburban and agricultural, but these forms are discouraged and limited to specific areas of the City's planning jurisdiction.

The preferred development form, the city neighborhood, or the hamlet neighborhood in the outlying areas of the planning jurisdiction, adapt urban conventions which were normal to the United States from colonial times until the 1940's and historically were based on the following design principles:

- All neighborhoods have identifiable centers and edges.
- Lots at the edge of a neighborhood are readily accessible to retail and recreation by non-vehicular means (a distance not greater than ¼ mile).
- Uses and housing types are mixed and in close proximity to one another.
- Street networks are interconnected and blocks are small.
- Civic buildings are given prominent sites throughout the neighborhood.

1.1.4. Organization of this Document.

The Unified Development Ordinance approaches regulations from the most general to the most specific across the document and within each Chapter, Article and Section. The document is organized into six Chapters: General Provisions; Decision-Making, Administration and Enforcement Responsibilities; Non-Conformities; Development Review Procedures; Use Districts; and, Land Use and Development Standards.

Chapter 1, General Provisions, set forth all of the regulations affecting the entire Title, including recitals, definitions and legal foundations and is the most general of all the Chapters of the Unified Development Ordinance.

Chapter 2, Decision-Making establishes the roles and responsibilities for administering and enforcing the regulations in the Unified Development Ordinance.

Chapter 3 addresses the issue of non-conformities in the City and how to deal with their eventual elimination.

In Chapter 4, Development Review Procedures, the processes, procedures, and application requirements for site plan review, subdivision plats, rezoning, Special Uses, planned developments and variations.

Chapter 5 establishes all of the various zoning districts in the City and the conditions for use in each district and, in some instances, for specific uses. The uses permitted in each District may be found in this Chapter, as well as the performance standards for all land uses in the City.

Finally, in Chapter 6, Land Use and Development Standards are found all of the regulations pertaining to the physical design, improvement and development of land in and within one and one-half miles of the City's limits. It is in this Chapter that you will find regulations governing the use of signs, landscaping, parking, utilities, street, sidewalk construction, and development in the floodplain.

Article 1.2

PURPOSE AND APPLICABILITY

1.2.1. Title and Jurisdiction. This Title shall be now, referred to, and cited as the "Unified Development Ordinance of the City of Genoa" and shall apply to structures and uses of land and water within the corporate limits of the City of Genoa.

1.2.2. Purpose and Intent. This Title is adopted for the following purposes:

- A. To promote the public health, safety, morals, comfort and general welfare of the people;
- B. To divide the City into zones or districts regulating and restricting therein the location and use of building, structures and land for residence, business, manufacturing and other specified purposes;
- C. To protect the character and stability of the agricultural, residential, business, and manufacturing areas within the City and to promote the orderly and beneficial development of such areas;
- D. To provide adequate light, air, privacy and convenience of access to property.

- E. To regulate the intensity of use of lot areas, and determine the area of open spaces surrounding buildings, necessary to provide adequate light and air and to protect the public health;
- F. To establish building lines and the location of buildings designed for residential, business, and manufacturing or other uses within such areas;
- G. To fix reasonable standards to which buildings or structures shall conform therein;
- H. To prohibit uses, buildings or structures incompatible with the character of development or intended uses within specified zoning districts;
- I. To limit congestion in the public streets and protect the public health, safety, convenience and general welfare by providing for the off-street parking of motor vehicles and the loading of commercial vehicles;
- J. To protect against fire, explosion, noxious fumes, and other hazards in the interest of the public health, safety, comfort and general welfare.
- K. To prevent the overcrowding of land and undue concentration of structures, so far as is possible and appropriate in each district, by regulating the use and bulk of buildings in relation to the land surrounding them;
- L. To conserve and enhance the taxable value of land and buildings throughout the City;
- M. To provide for the gradual elimination of non-conforming uses of land, buildings and structures which are adversely affecting the character and value of desirable development in each district;
- N. To prevent additions or alterations or remodeling of existing buildings or structures in such a way as to avoid the restrictions and limitations lawfully imposed herein;
- O. To facilitate and insure the preservation of sites, areas and structures of historical, architectural and aesthetic importance;
- P. To define and limit the powers and duties of the administrative officers and bodies provided herein;
- Q. To regulate or forbid any structure or activity which may hinder solar access to solar energy necessary for the proper functioning of a solar energy system;
- R. To enhance aesthetic values within the City;
- S. To encourage the use of alternative and renewable energy sources;
- T. To advance the goals and objectives of the City of Genoa Comprehensive Plan;
- U. To protect the character and the social and economic stability of all parts of Genoa and to encourage the orderly and beneficial development of the community through appropriate growth management techniques assuring the timing and sequencing of development, promotion of infill development in existing neighborhoods and non-residential areas with adequate public facilities, to assure proper urban form and open space separation of urban areas, to protect environmentally critical areas and areas premature for development;

- V. To guide public and private policy and action in order to provide adequate and efficient transportation, water, sewerage, schools, parks, playgrounds, recreation, and other public requirements and facilities;
- W. To provide the most beneficial relationship between the uses of land and buildings and the circulation of traffic throughout Genoa, having a particular regard to the avoidance of congestion in the streets and highways and the pedestrian traffic movements appropriate to the various uses of land and buildings, and to provide for the proper location and width of streets and building lines;
- X. To establish reasonable standards of design and procedures for subdivisions and resubdivisions in order to further the orderly layout and use of land, and to ensure proper legal descriptions and monumenting of subdivided land;
- Y. To ensure that public facilities and services are available concurrent with development and will have a sufficient capacity to serve the proposed subdivision or development and that the community will be required to bear no more than its fair share of the cost of providing the facilities and services through requiring developers and sub-dividers to pay fees, furnish land, or establish mitigation measures to ensure that the development or subdivision provides its fair share of capital facility needs generated by the development or subdivision;
- Z. To prevent the pollution of air, streams, and other surface waters; to assure the adequacy of drainage facilities; to safeguard the water table, and to encourage the wise use and management of natural resources throughout Genoa in order to preserve the integrity, stability, and beauty of the community and the value of land;
- AA. To preserve the natural beauty and topography of Genoa and to ensure appropriate development with regard to these natural features;
- BB. To provide for open space through the most efficient design and layout of the land, including the use of average density in providing for minimum width and area of lots, while preserving the density of development as established in the Genoa Comprehensive Plan and this Title;
- CC. To ensure that land is subdivided only when subdivision is necessary to provide for uses of land which market demand exists and which are in the public interest;
- DD. To remedy the problems associated with inappropriately subdivided lands, including premature subdivision, excess subdivision, partial or incomplete subdivision, scattered and low-grade subdivision;
- EE. To preserve the character and quality of City neighborhoods by maintaining the integrity of those areas which have a discernible character and are harmonious in design;
- FF. To raise the level of community expectations for the quality of its environment that bring value to the community, foster the attractiveness and functional utility of the community as a place to live and work;
- GG. To guide the physical growth and development of Genoa in accordance with the Genoa Comprehensive Plan
- HH. To prescribe penalties for the violation of and methods for the enforcement of the provisions of this Title or any amendment thereto.

- II. To prevent unwise developments from increasing the flood or drainage hazards to others.
- JJ. To protect new building and major improvements to building from flood damage.
- KK. To protect human life and health from the hazards of flooding.
- LL. To lessen the burden on the taxpayer for flood control projects, repairs to flood-damaged public facilities and utilities and flood rescue and relief operations.
- MM. To maintain property values and a stable tax base by minimizing the potential for creating flood blighted areas.
- NN. To make federally subsidized flood insurance available for property in the City by fulfilling the requirements of the National Flood Insurance Program. (1978 Code 24.06.01)

1.2.3. Separability. In accordance with the following, it is hereby declared that the several provisions of the Title are separate:

- A. If any court of competent jurisdiction determines any provision of the Title to be invalid, such determination shall not affect any other provision of this Title, not specifically included in the court's judgment order.
- B. If any court of competent jurisdiction determines any provision of the Title to be invalid as applied to a particular lot, parcel, building, structure or use, such determination shall not affect the application of such provision to any other lot, parcel, building, structure or use not specifically included in the court's judgment order.

1.2.4. Repeal of Conflicting Ordinances. All prior ordinances or parts of ordinances of the City of Genoa in conflict herewith are hereby repealed.

1.2.5. Publication and Effective Date. By authority of the Mayor and City Council, this Unified Development Ordinance shall be printed in pamphlet form and copies thereof shall be available at the Office of the City Clerk. This Title shall be in full force from and after its passage, approval and publication in the manner provided by law, and shall take effect on April 20, 1999.

1.2.6. Illustrations. The illustrations used in the Title are not drawn to scale and are intended only to graphically represent the requirements and concepts contained herein, and are not intended, nor should they be construed, to represent every situation or circumstance which may exist in the City of Genoa. When there is a conflict between the text of the Unified Development Ordinance and an illustration herein, the text shall prevail.

1.2.7. Zoning Map. The location and boundaries of the Districts established by this Title are indicated upon the map entitled, "Official Zoning Map, City of Genoa, Illinois" which, together with all explanatory matter thereon, is hereby adopted by reference and declared to be a part of this Zoning Ordinance. The Official Zoning Map shall be on file in the City Clerk's Office and shall be the final authority as to the current zoning status of land and buildings, subject to such authorized amendments which may be in effect.

1.2.8. Annexed Land. All territory which may hereafter be annexed to the City of Genoa, shall be classified AG District until otherwise classified by amendment as provided herein. In the event owners requesting annexation of their property desire a classification other than AG District, a petition shall be submitted for the desired zoning classification simultaneously with the petition for annexation.

1.2.9. Boundary Lines. In the event that uncertainties exist with respect to the intended boundaries of the various districts as shown on the Zoning Map, the following rules shall apply:

- A. District boundaries are the center lines of the streets or alleys, unless otherwise indicated. Where designation of a boundary line on the Zoning Map coincides with the location of a street or alley, the center line of such street or alley shall be construed to be the boundary of such district.
- B. Where the district boundaries do not coincide with the location of streets or alleys, but do coincide with lot lines, such lot lines shall be construed to be the boundary of such district.
- C. Where the district boundaries do not coincide with the location of streets, alleys, or lot lines, the district boundary shall be determined by the use of the scale shown on the Zoning Map.
- D. When a lot held in one ownership on the effective date of this Title is divided by a district boundary line, the entire lot shall be construed to be within the more restrictive district.
- E. All streets, alleys, public-ways, and railroad rights-of-way, if not otherwise specifically designated, shall be deemed to be in the same zone as the property immediately abutting upon such alleys, streets, public-ways and railroad rights-of-way. Where the center line of a street, alley, public-way or railroad rights-of-way serves as a district boundary, the zoning of such areas, unless otherwise specifically designated, shall be deemed to be the same as that of the property abutting up to such center line.
- F. Boundaries indicated as approximately following municipal boundary limits shall be construed to follow municipal boundary limits.
- G. Boundaries indicated as following railroad lines shall be construed to be midway between the main tracks.
- H. Boundaries indicated as following shore lines shall be construed to follow such shore lines, and in the event of change in the shore line shall be construed as moving with the actual shore line; boundaries indicated as approximately following the center lines of streams, rivers, canals, lakes, or other bodies of water shall be construed to follow such center lines.
- I. Streets, alleys, public ways or railroad right-of-way which are shown on the zoning map and which have heretofore been vacated, or which may be vacated hereafter, shall be in the same district as the land abutting both sides of the street, alley, public way or railroad right-of-way involved. If the land abutting each side of the street, alley, public way or railroad right-of-way, was located in different districts before the said street, alley, public way or railroad right-of-way was vacated, the center line of such vacated street, alley, public way or railroad right-of-way shall be the district boundary line of the respective zoning districts.

1.2.10. Interpretation.

- A. In their interpretation and application, the provisions of this Title shall be held to be the minimum requirements for the promotion of the public health, safety, morals and welfare.
- B. Where the conditions imposed by any provision of this Title upon the use of land or buildings or upon the bulk of buildings are either more restrictive or less restrictive than comparable conditions imposed by any other provisions of this code or of any other law,

ordinance, resolution, rule or regulations of any kind, the regulations which are more restrictive (for which impose higher standards or requirements) shall govern.

- C. Nothing in this Title shall be deemed to be a consent, license or permit to use any property, to locate, construct, or maintain any building, structure or facility, or to carry on any business, industry, occupation or trade.

1.2.11. Platted Building and Setback Lines. If a recorded subdivision plat imposes a building or setback line for a lot which is less than the minimum yard required by the applicable section of this Ordinance, then, notwithstanding the recorded plat, the minimum yard shall be the same as required by the applicable section of this Title.

1.2.12. Incorporation by Reference. Any and all standards and other codes, regulations and public records incorporated by reference into this unified development ordinance have been adopted in accordance with the requirement established in Chapter 65, Act 5, Section 1-3-1 *et seq.* and Chapter 50, Act 220, Section 1001 *et seq.* of the Illinois Compiled Statutes.

1.2.13. Disclosure by Trustee of Land Trust. Whenever any trustee of a land trust or any beneficiary or beneficiaries of a land trust make application to the City of Genoa or any of its agencies pursuant to the provisions of this Title relating to the land which is the subject of trust, any interest therein, improvements thereto, or use thereof, such application shall identify each beneficiary of such land trust by name and address and define his interest therein. All such applications shall be verified by the applicant in his capacity as trustee, or by the beneficiary as the beneficial owner of an interest in such land trust.

1.2.14. Successor to Rule or Standard Making Agencies. Whenever in this Title a governmental or private agency is referred to as the promulgator of a rule or standard shall continue to be incorporated by reference within this ordinance in the event that the same rule or standard is adopted by a successor agency in name or substance.

1.2.15. Private Agreements. This Title is not intended to abrogate any easement, covenant, or other private agreement; provided, that where the regulations of this ordinance are more restrictive or impose higher standards or requirements than easement, covenants, or other private agreements, the requirements of this ordinance shall be controlling.

1.2.16. Comprehensive Plan. The Comprehensive Plan referred to in this Ordinance shall be the comprehensive plan adopted by the Mayor and City Council on December 17, 2003, and any subsequent amendments and official map or maps passed pursuant to 65 ILCS 5/11-12-7. (Ord. 2006-4a- 02-20-2006)

Article 1.3

DEFINITIONS

1.3.1. Use of Definitions. In the construction of this code, the definitions contained in this article shall be observed and applied, except when the context clearly indicates otherwise;

1.3.2. Rules. In the construction of this Title, the rules contained in this Article shall be observed and applied, except when the context clearly indicates otherwise.

- A. Words used in the present tense shall include the future; and words used in the singular number shall include the plural number, and the plural, the singular.
- B. The words "shall" and "will" are mandatory and not discretionary.

- C. The word "may" is permissive.
- D. The word "lot" shall include the words "plot", "piece", and "parcel".
- E. Unless otherwise specified, all distances shall be measured horizontally.
- F. Whenever a word or term defined hereinafter appears in the text of this Title, its meaning shall be construed as set forth in the definition thereof.
- G. The masculine gender shall include the feminine and neuter.
- H. All measured distances shall be expressed in feet and shall be calculated to the nearest tenth (.10) of a foot.
- I. The word "person" shall include the words "association", "corporation", "estate", "governmental agency", "individual", "joint venture", "partnership", "venture", or any other legal entity.
- J. The word "building" shall include the word "structure".
- K. The phrase "used for" shall include the phrases "arranged for", "designed for", "intended for", "maintained for", and "occupied for".

1.3.3. Definitions. The following words and terms when used in the interpretation and administration of this Title shall have the meaning set forth herein except where otherwise specifically indicated. Words and terms not defined here shall be defined as specified in the latest published edition of Webster's New Collegiate Dictionary.

Accessory Structure (Use): shall mean a building (use) customarily incidental to and auxiliary to the use of a principal building (use) on the same premises with such principal building (use). When the wall of an accessory building is a part of or joined to the wall of the principal building such accessory building shall be construed as a part of the principal building.

Adult Care Center: shall mean a building or group of buildings providing daytime care to six (6) or more handicapped persons or senior citizens unrelated by blood or marriage to, and not legal wards or foster children of the attendant adult within an occupied residence.

Adult Use: See Section 4.3.4(E) herein. Adult Use shall not include any Adult-Use Cannabis Business Establishment.

Adult-Use Cannabis Business Establishment: An adult-use cannabis cultivation center, adult-use cannabis craft grower, adult-use cannabis processing organization or processor, adult-use cannabis infuser organization or infuser, adult-use cannabis dispensing organization, or adult-use cannabis transporting organization or transporter.

Adult-Use Cannabis Craft Grower: A facility operated by an organization or business that is licensed by the Illinois Department of Agriculture to cultivate, dry, cure and package cannabis and perform other necessary activities to make cannabis available for sale at a dispensing organization or use at a processing organization or processor, per the Cannabis Regulation and Tax Act, (P.A. 101-0027), as it may be amended from time-to-time, and regulations promulgated thereunder.

Adult-Use Cannabis Cultivation Center: A facility operated by an organization or business that is licensed by the Illinois Department of Agriculture to cultivate, process, transport and perform necessary activities to provide cannabis and cannabis-infused products to licensed cannabis business establishments,

per the Cannabis Regulation and Tax Act, (P.A. 101-0027), as it may be amended from time-to-time, and regulations promulgated thereunder.

Adult-Use Cannabis Dispensing Organization: A facility operated by an organization or business that is licensed by the Illinois Department of Financial and Professional Regulation to acquire cannabis from licensed cannabis business establishments for the purpose of selling or dispensing cannabis, cannabis-infused products, cannabis seeds, paraphernalia or related supplies to purchasers or to qualified registered medical cannabis patients and caregivers, per the Cannabis Regulation and Tax Act, (P.A. 101-0027), as it may be amended from time-to-time, and regulations promulgated thereunder.

Adult-Use Cannabis Infuser Organization or Infuser: A facility operated by an organization or business that is licensed by the Illinois Department of Agriculture to directly incorporate cannabis or cannabis concentrate into a product formulation to produce a cannabis-infused product, per the Cannabis Regulation and Tax Act, (P.A. 101-0027), as it may be amended from time-to-time, and regulations promulgated thereunder.

Adult-Use Cannabis Processing Organization or Processor: A facility operated by an organization or business that is licensed by the Illinois Department of Agriculture to either extract constituent chemicals or compounds to produce cannabis concentrate or incorporate cannabis or cannabis concentrate into a product formulation to produce a cannabis product, per the Cannabis Regulation and Tax Act, (P.A. 101-0027), as it may be amended from time-to-time, and regulations promulgated thereunder.

Adult-Use Cannabis Transporting Organization or Transporter: An organization or business that is licensed by the Illinois Department of Agriculture to transport cannabis on behalf of a cannabis business establishment or a community college licensed under the Community College Cannabis Vocational Training Pilot Program, per the Cannabis Regulation and Tax Act, (P.A. 101-0027), as it may be amended from time-to-time, and regulations promulgated thereunder. (Ordinance 2019-39, 12-17-2019)

Agriculture: shall mean the land, buildings and accessory structures used for (i) producing plants by tilling the soil or through floriculture, horticulture, nurseries, orchards, forestry, viticulture, or (ii) when animal products are produced, through apiculture, dairying, pasturage, or the breeding, raising and feeding of farm animals, except commercial feed lots and feeding of garbage to animals, or the breeding, raising and feeding of canines and felines for commercial purposes, or the breeding raising and feeding of laboratory animals. Accessory structures customarily incidental to agricultural activities include, but are not limited to, the farm dwelling, dwellings for tenants full-time farm workers, and dwelling or lodging rooms for seasonal workers, silos, grain, storage bins and equipment sheds.

Alley: shall mean a public or private way primarily designed to serve as a secondary means of access to those parcels whose principal frontage is on a public street.

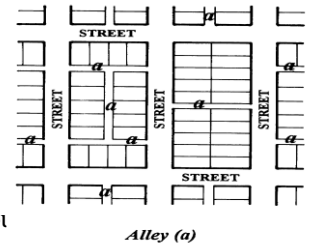

Alterations, Structural: see structural alteration.

Amusement Arcade: shall mean an establishment devoted to the use of for amusement devices.

Animals, Farm: shall mean the fowl, ovine, caprine, bovine, equine, fur-bearing, and other species domesticated for agricultural uses.

Animal Hospital: shall mean a place where animals are given medical or surgical treatment and the boarding of animals is limited to short-term care incidental to the hospital use.

Antenna: shall mean an arrangement of wires, metal rods, parabolic or concave dishes, or similar materials used for the transmission and/or reception of electromagnetic waves.

Antenna Tower: shall mean any structure designed for the purpose of mounting an antenna.

Apartment: shall mean a room or suite of rooms in a multiple dwelling structure, which is arranged, designed, used or intended to be used as a residence for one family.

Apartment Hotel: shall mean a building or portion thereof designed for or containing both individual guest rooms or suites of rooms, and dwelling units, the majority of which are for permanent guests. Maid and janitor service may be provided but kitchen facilities are not necessarily included.

Apiculture: shall mean beekeeping.

Arbor: shall mean a leafy, shady recess formed by tree branches, or latticework intertwined with shrubs or vines.

Arcade: shall mean a building frontage type where the building façade above the ground level overlaps the public sidewalk while the ground level portion of the building maintains a setback or is located at the build-to line.

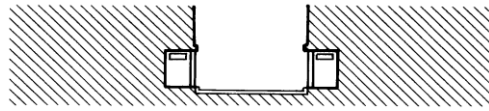

Arcade

Artwork: shall mean any object, such as a sculpture, figure, statue, monument, painting, photograph or the like constructed out of such materials as stone, clay, wood, or metals, which exhibits individual expression and creativity.

Assisted Living Establishment: shall mean a home building, residence, or any other place where sleeping accommodations are provided for at least three (3) unrelated adults, at least eighty-percent (80%) of whom are fifty-five (55) years of age or older and where the following are provided consistent with the purpose of the Assisted Living and Shared Housing Act (210 ILCS 9/1 *et seq.*): (a) services consistent with a social model that is based on the premise that the resident’s unit in assisted living and shared housing is his or her own home; (b) community-based residential care for persons who need assistance with activities of daily living, including personal, supportive, and intermittent health-related services available twenty-four (24) hours per day, if needed, to meet the scheduled and unscheduled needs of a resident; (c) mandatory services, whether provided directly by the establishment or by another entity arranged for by the establishment, with the consent of the resident or the resident’s representative; and (d) a physical environment that is homelike setting that includes the following and such other elements as established by the Illinois Department of Public Health in conjunction with the Assisted Living and Shared Housing Advisory Board: individual living units each of which shall accommodate small kitchen appliances and contain private bathing, washing, and toilet facilities, or private washing and toilet facilities with a common bathing room readily accessible to each resident. Units shall be maintained for single occupancy except in cases in which two residents choose to share a unit. Sufficient common space shall exist to permit individual and group activities. “Assisted Living Establishment” shall not mean any of the following: (a) a home, institution, or similar place operated by the federal government or the State of Illinois; (b) a long term care facility licensed under the Nursing Home Care Act (210 ILCS 45/1-101 *et seq.*), however, a long term care facility may convert distinct parts of the facility to assisted living; (c) a hospital, sanitarium, or other institution, the principal activity of which is the diagnosis, care, and treatment of human illness and that is required to be licensed under the Hospital Licensing Act (210 ILCS 85/1 *et seq.*); (d) a child care facility; (e) a community living facility; (f) a nursing home or sanitarium operated solely by and for persons who rely exclusively upon treatment by spiritual means through prayer in accordance with the creed or tenants of a well-recognized church or religious denomination; (g) a facility licensed by the Department of Human Services as a community-integrated living arrangement; (h) a supportive residence; (i) a life care facility; (j) a free-standing hospice facility; (k) a shared housing establishment; and (l) a supportive living facility.

Awning: shall mean a roof-like cover that is temporary in nature and that projects from the wall of a building for the purpose of shielding a doorway or window from the elements.

Balcony: shall mean an elevated platform open to the elements, not supported by the ground and projecting from an upper story and enclosed entirely by a railing.

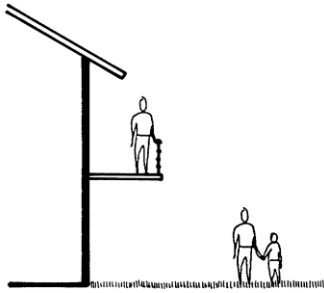

Balcony

Bar: shall mean a room(s) or a counter accessory to the principal use of the building or tenant space in the building where alcoholic beverages are served for consumption on the premises and may provide for dancing.

Basement: shall mean a space within a building which has one-half or more of its floor-to-ceiling height above the average level of the adjoining ground and with a floor-to-ceiling height of not less than six and one-half (6.5) feet, and not more than fourteen (14) feet. If $x < y$ see Cellar.

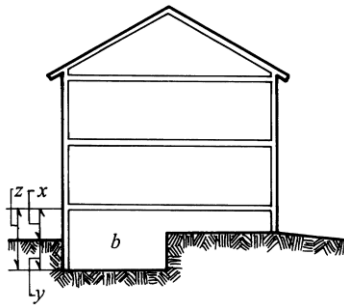

Basement (b),

Where $x > y$ and $z \leq 14$ feet

Bay Window: shall mean a window projecting beyond the wall line of the building and not supported by a foundation.

Bed and Breakfast Lodge, Inn: shall mean a residential building containing not more than five (5) lodging rooms offered for rent on a daily basis to transient guests for a continuous period of thirty (30) days or less, and containing the owner's principal residences; where provision of meals is limited to the breakfast meal served exclusively to overnight guests between the hours of 5:00 A.M. and 10:00 A.M.

Bedroom: shall mean any room designed, intended, or used principally for sleeping purposes, including a study or a den.

Berm: shall mean soil of good quality, uncompacted, raised generally above the surrounding finish grade with side slopes generally no steeper than three (3) horizontal units to one (1) vertical unit (3:1); generally a man-made slope.



Berm

Block: shall mean a tract of land bounded by streets, or by a combination of streets and public parks, cemeteries, railroad right-of-way, shorelines of waterways, municipal, township and county boundary lines.

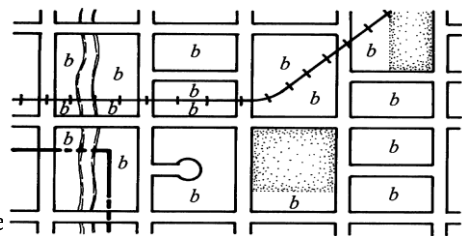

Block (b)

Body Shop, Motor Vehicle: shall mean any building or portion the of a motor vehicle body or frame, or painting of motor vehicles. It may be performed as an accessory function to the body work.

Breezeway: shall mean a covered pedestrian passageway, as between a house and a garage, but otherwise exposed to the elements.

Buildable Area: shall mean the area of a lot or parcel remaining after yard, parking or any other requirements of this ordinance have been satisfied.

Building: shall mean a roofed, structure designed or intended for the enclosure, shelter or protection of persons, animals or other property. All forms of vehicles, even if immobilized, are excluded from this definition.

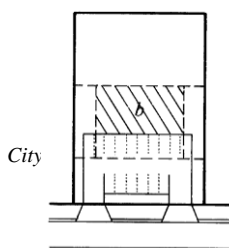

Building Coverage: shall mean the area of a zoning lot occupied by the principal building(s) and accessory structures.

Building Line: shall mean a line parallel to adjacent property lines at a specified distance from said property lines establishing the minimum open space to be provided between the building and an adjacent lot line. Also known as "building setback line" or "setback line" or "build-to line."

Build-to Line: See **Building Line**.

Building Height: shall mean the vertical distance of a building measured at the midpoint of the front wall of a building between the finished grade at the front wall of the building and the highest point of the roof or parapet walls, excluding chimneys, mechanical equipment, cooling towers, storage tanks, bulkheads, spires, water towers, and antennae attached to or resting upon the building.

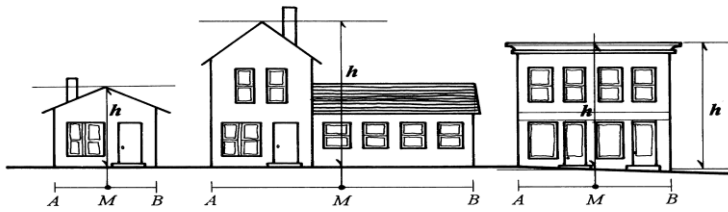

Building Height (h)

Where building height (h) is measured at M, the midpoint between A and B

Bulk: shall be the term used to describe the size and mutual relationships of buildings and other structures as to size, height, coverage, shape, location of exterior walls in relation to lot lines, to the center line of streets, to other walls of the same building, and to all open spaces relating to the building or structure.

Burial Building: shall mean any building used for the interment of bodies or other remains of persons who have died, including mausoleums, vaults or columbaria.

Business: shall mean an occupation, employment or enterprise which occupies time, attention, labor and materials, or where merchandise is exhibited, bought or sold, or where services are offered for compensation.

Caliper: shall mean the diameter of a tree trunk six (6) inches above the existing grade or proposed planted grade and in conformance with the provisions of the Code of Standards (Z60.1-1986 or latest version) published by the American Association of Nurserymen, Inc.

Car Wash: shall mean a structure, or portion thereof, containing facilities for washing automobiles, and may utilize production-line methods using a conveyor, blower, steam-cleaning device; or other mechanical devices, and may include detailing services.

Carport: shall mean a roofed structure permanently open on two or more sides designed for or occupied by parked or stored vehicles. A carport shall not be construed as a *porte-cochere*.

Cellar: shall mean a space within a building with less than one-half of its floor-to-ceiling height above the average finished grade of the

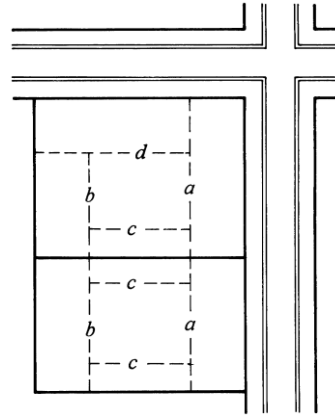

Building Lines (Setbacks)

Where a = Front Building Line
 b = Rear Building Line
 c = Side Building Line
 d = Corner Side Building Line

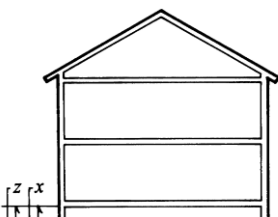

adjoining ground or with a floor-to-ceiling height of less than six and one-half (6.5) feet. If $x > y$ see basement.

City: shall mean the City of Genoa, an Illinois municipal corporation.

Child Care Facility: shall mean any person, group of persons, agency, association or organization, whether established for gain or otherwise, who or which receives or arranges for care or placement of one or more children, unrelated to the operator of the facility, apart from the parents, with or without the transfer of the right of custody in any facility as defined in the Child Care Act (225 ILCS 10/2 *et seq.*), established and maintained for the care of children. Also see “Day Care Center” and “Day Care Home”.

Child Care Institution: shall mean a child care facility where children are received and maintained for the purpose of providing them with care or training or both. “Child care institution” includes residential schools primarily serving ambulatory handicapped children, and those operating a full calendar year, but does not include: (a) any State-operated institution for child care established by legislative action; (b) any juvenile detention or shelter care home established and operated by any county; (c) any institution, home, place or facility operating under a license pursuant to the Nursing Home Care Act (210 ILCS 45/1-101 *et seq.*); (d) any bonafide boarding school in which children are primarily taught branches of education corresponding to those taught in public schools, grades one through twelve, and which operates on a regular academic school year basis; or, (e) any facility licensed as a “group home”.

Club or Lodge: shall mean a group of people organized for a common purpose to pursue common goals, interest, or activities and usually characterized by certain membership qualifications, payment of dues, regular meeting, and constitution and by-laws.

Cluster: shall mean plant material installed as a clump or group as opposed to individual specimens. An odd number of shrubs is desired.

Cocktail Lounge: shall mean a room or an establishment where alcoholic beverages are served for consumption on the premises and may provide for dancing or live entertainment on the premises.

Commercial Use: shall mean an activity carried out for pecuniary gain.

Country Club: shall mean a land area and building containing recreational facilities, clubhouse and usual accessory uses, typically open only to members and their guests for a membership fee.

Commercial Recreation: shall mean any establishment or use of land which provides active recreational opportunities, including but not limited to, waterslides and water parks, batting cages, miniature golf, go-cart racing, carnival games, and the like.

Condominium: shall mean an estate in real property consisting of an individual interest in common with other purchasers in a portion of real property, together with a separate interest in space in a building and/or separate interest in other portions of such real property.

Convalescent Home or Rest Home: shall mean an establishment for the care of the aged or infirm, or a place of rest for those suffering bodily disorders, but excluding contagious or communicable diseases and excluding surgery.

Conventional Energy System: shall mean an energy system utilizing fossil fuel, nuclear, or hydroelectric energy and components of such system, including transmission lines, burners, furnaces, tanks, boilers, related controls, distribution systems, room or area units, and other components.

Cottage, Accessory: shall mean a room or group of rooms meeting habitable room sizes as required by the City Building Code which are arranged, designed, used and intended for use as living quarters for one household, including sleeping, cooking, eating and sanitation facilities, and may be located in a free-standing accessory building and having its own exterior entrance.

Cottage Office, Accessory: shall mean a room or group of rooms meeting habitable room sizes as required by the City Building Code which are arranged, designed, used and intended for use as a private office and having no sleeping, cooking, eating or sanitation facilities, located in a freestanding accessory building and having its own exterior entrance.

Crawl Space: shall mean a space between the ceiling of one story and the floor of the next story above, which normally contains pipes, ducts, wiring and lighting fixtures and permits access but is too low for an individual to stand. A crawl space may be a cellar area no more than four and one-half (4.5) feet in height, or, if between a ceiling and a shed roof or a flat roof, a cockloft.

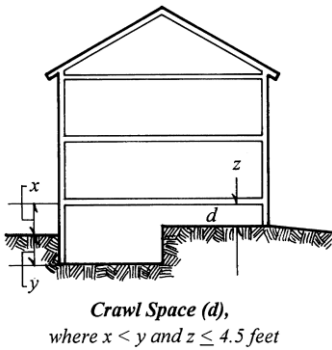

Cul-de-sac: Shall mean a short street having one end open to traffic and being terminated at the other end by a vehicular turn-around.

Day Care Center: shall mean a facility commonly called "infant and toddler centers", "child care centers", "day nurseries", "nursery schools", "play groups", "kindergartens", and "after school programs for young school age children" licensed by the Illinois Department of Children and Family Services.

Day Care Home: shall mean a residence licensed by the Illinois Department of Children and Family Services for the care of at least three (3) but not more than twelve (12) children for less than twenty-four (24) hours per day. The maximum number of children permitted includes the family's natural, foster or adopted children and all other persons under the age of twelve. The term does not include residences or facilities which receive only children from a single household.

Deciduous: shall mean plants which do not retain leaves or needles during the winter season of the year.

Deck: shall mean a level, unenclosed platform serving as a floor and located above the finished grade, and usually directly adjoining or attached to a building.

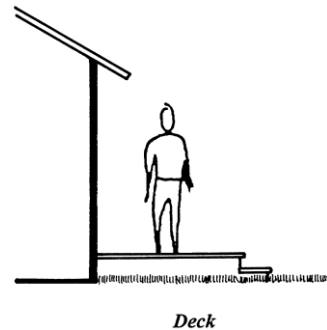

Detention Basin: See Article 6.15 of this Ordinance.

Development Administrator: shall mean the City Administrator or other individual designated by the Mayor and City Council to enforce this Ordinance, or his or her designee.

Disability: shall mean a personal condition which is: (i) attributed to mental, intellectual, or physical impairment or a combination of mental, intellectual, or physical impairments; (ii) likely to continue for a significant amount of time or indefinitely; and, (iii) results in functional limitation in three or more of the following areas of major life activities self-care: receptive or expressive language; learning; mobility; self-direction; capacity for independent living; economic self-sufficiency; and reflects the person's need for a combination and sequence of special interdisciplinary or generic care treatment, or other service of life-long or extended duration, but is not the result of a communicable disease or substance abuse or alcohol abuse.

District, Zoning: shall mean a section of the corporate areas of the City of Genoa within which the regulations governing the use of land are uniform.

Dog Run: shall mean an enclosed outdoor area intended exclusively for the exercising and/or containment of dogs or other animals. (Ord. 2010-13, 07-06-2010)

Dooryard: shall mean a building frontage type where the building façade is set back from the frontage line and the space between the frontage line and the building façade is elevated.

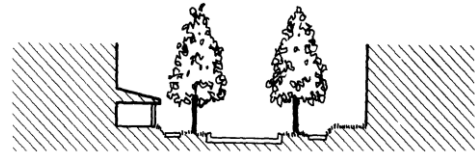

Door Yard

Dormitory: shall mean a building where sleeping accommodations, dining facilities and common bathroom facilities are provided for more than ten (10) unrelated individuals, exclusive of the resident family, who are students or members of a religious order, college, university, convent, monastery or other institutional use.

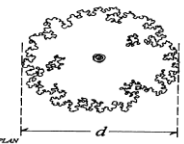
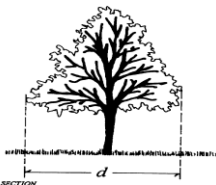

Drip Line (d)

Drip Line: shall mean the zone lying between the trunk of a tree or shrub and the extreme outer edge of the leaf and branch structure, i.e., the diameter of the leaf and branch structure extended vertically down to the soil surface.

Drive-Up Facility: shall mean a facility or establishment which is designed, intended or used for transaction of business with customers in automobiles. A drive-up facility may be the principal or an auxiliary function of the business. A drive-up facility does not include mail or parcel collection boxes.

Driveway: shall mean a private roadway providing vehicular access from a street or alley to adjacent property.

Dwelling: shall mean a building or portion thereof designed or used exclusively for residential occupancy, including single-family, two-family, and multiple-family dwellings, but not including hotels, motels or lodging houses.

Dwelling, Apartment: shall mean a building or portion thereof in which a dwelling unit or a portion thereof is located above or below another dwelling unit, or above or below any other independently used portion of the building.

Dwelling, Attached Single-Family: shall mean a building consisting of dwelling units each of which is attached by common vertical wall to at least one other dwelling unit with each dwelling unit having a separate exterior entrance and occupying the ground, including, but not limited to, the following: "townhouse", "row house", "duplex", "four-plex", "three-plex". In addition, no dwelling unit or portion thereof within an attached dwelling shall be located above or below another dwelling unit, and each dwelling unit shall have its primary access to the outside on the ground floor.

Dwelling, Detached Single-Family: shall mean a free-standing building containing one dwelling unit.

Dwelling, Duplex: shall mean a building containing two (2) dwelling units where one (1) dwelling unit is joined with the other dwelling unit on one (1) side by a common wall. No dwelling unit or portion thereof within a duplex dwelling shall be located above or below another dwelling unit. Each dwelling unit shall have an exterior located on the ground floor.

Dwelling, Efficiency: shall mean a dwelling unit consisting of not more than one habitable room together with cooking and sanitary facilities.

Dwelling, Multiple-Family: shall mean a building, or portion thereof, consisting of three (3) or more dwelling units with varying arrangements of entrances and party walls and one or more of the dwelling units do not occupy the ground, including but not limited to the following: "apartment", "condominium", "cooperative", "manor home", "coach house", "three-flat", and "six-flat".

Dwelling, Rooming House: shall mean a building or a portion thereof utilized as a dwelling unit which is the primary residence of the owner and which contains lodging rooms for occupancy at a monthly rate of compensation by permanent residents who are not related to the owner. A rooming house maintains a common household. Rooming house dwellings include boarding houses and lodging houses, but exclude residential care facilities.

Dwelling, Two-Family: shall mean a building consisting of two (2) dwelling units where one dwelling unit is located on the first floor and the second dwelling unit is located on the second floor and each dwelling may or may not have a separate exterior entrance.

Dwelling Unit: shall mean one or more rooms, including at least one complete permanently installed bathroom and not more than one complete kitchen facility arranged, designed, or used a living quarters for not more than one family. Each dwelling unit shall have an independent entrance, cooking, sleeping and sanitary facilities.

Easement: shall mean a legal interest in land, granted by the owner to another person, which allows that person(s) the use of all or a portion of the owner's land, generally for a stated purpose including, but not limited to the placement of utilities.

Eave: shall mean the projecting lower edges of a roof, overhanging the wall of a building.

Evergreen: shall mean plants which continuously retain leaves or needles over four seasons of the year.

Extended Care Facility: shall mean an institution or a distinct part of an institution which is licensed or approved to provide health care under medical supervision for twenty-four (24) or more consecutive hours to two or more patients.

Façade: shall refer to matters of spatial definition and shall mean the vertical surface of a building set along a frontage line. Facades are subject to visual definition by building height, setback lines, recess lines, and transition lines.

Family: shall mean one of the following, except as otherwise provided herein:

- A. Two or more individuals related by blood, marriage or legal adoption (including foster children), together with domestic servants and not more than two gratuitous guests, living as a single, not-for-profit housekeeping unit occupying a dwelling unit.
- B. Three or fewer individuals not related by blood, marriage or legal adoption (including foster children), living as a single, not-for-profit housekeeping unit occupying a dwelling unit. Servants or guests residing with said family shall be included in the unrelated individuals attained by this definition, and shall not be in addition hereto.
- C. No more than two individuals who are not necessarily related to each other by blood, and their dependents, together with domestic servants and not more than two gratuitous guests, living as a single, not-for-profit housekeeping unit occupying a dwelling unit. (Ord. 2006-04, 02-21-2006; Ord. 2006-05,02-20-2006)

Farm: shall mean any tract of land ten (10) acres or more in area being used for agriculture purposes.

Farm Homestead: shall mean the dwelling located on a farm that is the residence of the farm owner or tenant, operator, or caretaker.

Farm Owner: shall mean the person holding title to the farm land.

Farm, Research or Experimental: shall mean an agriculture use, including buildings and land, for the purpose of obtaining new knowledge in agriculture processes or procedures.

Feed Lot, Commercial: shall mean a structure or area of land in which twenty-five (25) or more farm animal units are confined for a limited period of time prior to being shipped to market. One farm animal unit shall be equivalent to one head of cattle, seven hogs, nine sheep or goats, or one hundred-forty (140) chickens or other fowl.

Fence: shall mean a free standing structure of metal, masonry, composition or wood or any combination thereof permanently installed by being partially buried in the ground and rising above ground level, and used for confinement, screening, or partition purposes, including the following: (i) *Fence, decorative*; A fence having a regular pattern that has more than twenty-five percent (25%) of the surface open and unobstructed to vision, light and air, when viewed perpendicular to the plane of the fence and intended primarily for aesthetic purposes; (ii) *Fence, natural*; A living barrier that is made of natural growth, such as shrubs, hedges, evergreens and similar planted vegetation; and, (iii) *Fence, solid*; a fence having a regular pattern that has less than twenty-five percent (25%) of the surface open and unobstructed to vision, light and air, when viewed perpendicular to the plane of the fence and intended primarily for privacy or security purposes.

Festoon Lighting: shall mean a group of two or more incandescent light bulbs hung or strung overhead, or on a building or structure, which are exposed to persons on a public right-of-way, or which are not shaded or hooded to prevent the direct rays of light from being visible from the property line.

Floor Area, Gross (GFA): shall mean the sum of the gross horizontal areas of the several floors of the building measured from the exterior faces of the exterior walls or from the center line of walls separating two buildings and shall include cellar floor area; elevator shafts, escalators and stairwells at each floor; floor space used for mechanical, telephone and electrical equipment, open or enclosed, except when located on the roof; penthouses, except mechanical penthouses; attic space having headroom of seven feet, ten inches (7'10") or more; interior balconies and mezzanines; enclosed porches; outdoor display areas; interior off-street parking and loading facilities; and, floor area devoted to accessory uses.

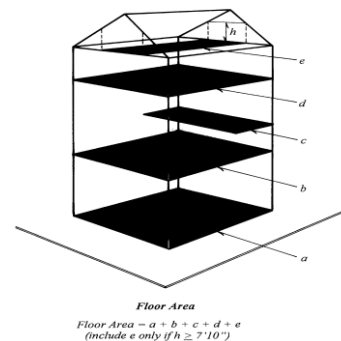

Floor Area, Net (NFA): shall mean the gross floor area of the several floors of the building less cellar floor area when used for storage; elevator shafts, escalators and stairwells at each floor; floor space used for mechanical, telephone and electrical equipment, open or enclosed, except when located on the roof; penthouses, except mechanical penthouses; attic space having headroom of seven feet, ten inches (7'10") or more; public restrooms, interior balconies and mezzanines and other interior common areas designed primarily for pedestrian circulation; enclosed porches; outdoor display areas; interior off-street parking and loading facilities; and, entrance lobbies.

Floor Area Ratio (FAR): shall mean the gross floor area of the building or buildings measured from the exterior faces of the exterior walls or from the center line of walls separating attached buildings, on that lot divided by the area of such lot, or in the case of planned unit developments, by the net site area.

Food Store: shall mean an establishment where the principal use is the retail sale of food, including meats, produce, bakery and dry goods, and may include accessory preparation of food for consumption on or off the premises.

Forecourt: shall mean a building frontage type where the building façade is set back and is replaced with a low wall at the frontage line.

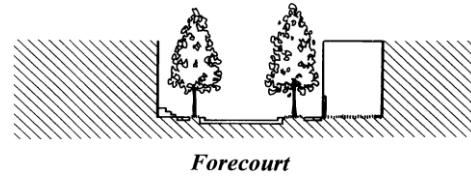

Fraternal Organization: shall mean a group of individuals formally organized for a common interest, usually cultural, religious, or entertainment, with regular meetings and formal written membership requirements.

Front Lawn: shall mean a building frontage type where the building façade is set back substantially from the frontage line and is uninterrupted by fences, porches and other structures.

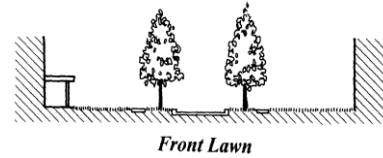

Garage, Private: shall mean a building, or an accessory portion of the principal building, for the private use of the owner or occupant of the principal building, designed or used for the storage and shelter of motor vehicles with no facilities for mechanical service or repair of a retail nature.

Garage, Public: shall mean a building or portion thereof, other than a private garage, designed or used for the care, storage, of motor vehicles, or where such vehicles are kept for remuneration, hire or sale.

Garden Center: shall mean a place of business where plants, nursery products, fertilizers, potting soil, garden tools and utensils are sold to the customer. The sales and storage of the merchandise is permitted in any open area which must be attached to the building and fenced.

Garden Shed: shall mean an accessory structure used primarily for the storage of residential garden or lawn equipment and supplies.

Gasoline Station: shall mean any building, land area, or other premises, or a portion thereof, used or intended to be used only for the retail dispensing or sale of motor vehicle fuels and fluids.

Grain and Vegetable Oil conversion or reclamation to Fuel: shall mean a use in which new or used vegetable oil, or vegetables or grains such as soybeans, canola, or corn, are pressed to produce oil, which oil is then treated to create a product that may be used as diesel engine fuel, but specifically excluding any production or distilling of product into alcohol or gasohol types of fuels, and further excluding any petroleum products or any blending of petroleum based products with the grain or vegetable oils and further excluding any animal fat or oil. (Ord. 2006-35, 11-06-2006)

Ground Covers: shall mean woody or non-woody plants with a maintained or unmaintained average mature height less than twelve (12) inches.

Group Home: a dwelling unit occupied on a relatively permanent basis in a family-like environment by unrelated persons with disabilities. Professional support staff, provided by a sponsoring agency, either living with residents on a 24-hour basis or present whenever the residents are present at the dwelling unit, shall be required unless a special use permit is issued by the City to eliminate the supervision requirement. A group home shall comply with the zoning regulations for the district in which the site is located. (Ord. 2006-04, 02-21-2006)

Habitable Space: shall mean space in a structure designed for living, sleeping, eating or cooking, but excluding bathrooms, toilet compartments, closets, halls, storage or utility spaces and similar areas.

Health Club: shall mean a facility designed for the major purpose of physical conditioning and fitness or weight reduction which includes, but is not limited to such equipment as free weights, weight resistance machines, cardiovascular machines, whirl pools, saunas, showers, lockers, swimming pools, or basketball and racquet courts. This shall not include municipal owned recreation buildings.

Height (for landscaping): shall mean reference to the total finished height of a structure or general mature height of plant materials installed above the adjacent elevation of soil or paving. Specified height of a screening may be provided by a berm, combination of a berm and planting, or a structure unless otherwise specified herein.

Home Improvement Center: shall mean an establishment where home improvement materials, including but not limited to, kitchen and bathroom accessories and fixtures, wall coverings, window coverings, heating and air conditioning, plumbing and electrical supplies, painting and decorating material, tools and residential construction and remodeling materials and supplies are sold for retail. Outdoor storage of building materials may be provided but is accessory to the principal use and structure and only as permitted by the district in which it is located.

Home-Based Business: shall mean a business, profession, occupation or trade conducted for pecuniary gain entirely within a residential building, or, when permitted by this Title, within a structure that is accessory to a residential building.

Hospice, Freestanding: shall mean a home, apartment building, or similar building providing living quarters that is owned or operated by a person licensed to operate as a full hospice; and, at which hospice services are provided to facility residents. A building that is licensed under the Hospital Licensing Act (210 ILCS 85/1 *et seq.*) or the Nursing Home Care Act (210 ILCS 45/1-101 *et seq.*) is not a hospice. As used in this definition, “hospice services” means palliative and supportive care provided to a hospice patient and his family to meet the special needs arising out of the physical, emotional, spiritual and social stresses which are experienced during the final stages of illness and during dying and bereavement.

Hospital: shall mean an institution providing primary health services and medical or surgical care to in-patients suffering from illness, disease, injury, deformity and other abnormal physical or mental conditions and including as an integral part of the institution, related facilities such as laboratories, pharmacies, out-patient facilities or training facilities.

Hotel: shall mean a building designed for transient occupancy containing lodging rooms or suites accessible from a common interior hall or entrance, providing living, sleeping and sanitary facilities. A central kitchen, meeting rooms, dining room and recreation room are generally provided.

Joint Solar Energy System: shall mean a solar energy system that supplies energy for structures or processes on more than one lot or in more than one condominium unit or leasehold, but not to the general public and involving at least two owners or users.

Junk Yard: see **Wrecking Yard, Vehicle.**

Kennel: shall mean any lot or premises, or portion thereof, where household pets are bred, trained, boarded or groomed for commercial purposes.

Laboratory: shall mean a building, or portion thereof, in which scientific research, investigation, testing, analyzing, or experimentation is conducted on a regular basis but not devoted to the manufacturing of a product or products.

Life Care Facility: shall mean a place or places in which a provider undertakes to provide residents with nursing services, medical services or personal care services, in addition to maintenance services, for a term in excess of one (1) year or for life pursuant to a life contract. The term also means a place or places in which a provider undertakes to provide such services to a non-resident.

Liquor Store: shall mean a place of business selling beer, wine and/or distilled liquors at retail, to the general public in sealed bottles or containers for consumption or use away from the premises where said establishment is located.

Long Term Care Facility: shall mean a private home, institution, building, residence, or any other place, whether operated for profit or not, or a county home for the infirm and chronically ill operated pursuant to Division 5-21, County Homes, or Division 5-22, Homes for the Aged, of the Counties Code (55 ILCS), or any similar institution operated by a political division of the State of Illinois, which provides, through its ownership or management, personal care, sheltered care, maintenance or nursing for three (3) or more persons, not related to the applicant or owner by blood or marriage. It includes skilled nursing facilities and intermediate care facilities as those terms are defined in Title XVIII and Title XIX of the federal Social Security Act. It also includes homes, institutions, or other places operated by or under the authority of the Illinois Department of Veterans' Affairs. "Long Term Care Facility" shall not mean any of the following: (a) a home, institution, or similar place operated by the federal government or agency thereof, or the State of Illinois, other than homes, institutions, or other places operated by or under the authority of the Illinois Department of Veterans' Affairs; (b) a hospital, sanitarium, or other institution, the principal activity of which is the diagnosis, care and treatment of human illness and that is required to be licensed under the Hospital Licensing Act (210 ILCS 85/1 *et seq.*); (c) a child care facility; (d) a community living facility; (e) a nursing home or sanitarium operated solely by and for persons who rely exclusively upon treatment by spiritual means through prayer in accordance with the creed or tenants of a well-recognized church or religious denomination; (f) a facility licensed by the Department of Human Services as a community-integrated living arrangement; (g) a supportive residence; (h) an Alzheimer's disease management center alternative health care model licensed under the Alternative Health Care Delivery Act (210 ILCS 3/1 *et seq.*); and, (k) a supportive living facility. As used herein, "maintenance" means food, shelter and laundry services; "personal care" means assistance with daily meals, dressing, movement, bathing, or other personal needs or maintenance, or general supervision and oversight of the physical and mental well-being of an individual, who is incapable of managing his person whether or not a guardian has been appointed for such individual; and, "sheltered care" means maintenance and personal care.

Lot: shall mean land which is part of a subdivision, the plat of which has been recorded in the Office of the County Recorder of Deeds, of DeKalb County or it may be and consist of a part of such recorded lot, or it may include parts of or a combination of several lots when adjacent to one another and used as one parcel.

Lot Area: shall mean the area of a horizontal plane bounded by the front, side and rear lot lines. Calculation of the required minimum lot area shall not include street right-of-way, whether dedicated to the public or a private street or easement for street purposes and, when adjacent a water course, drainage way, channel or stream, the area included in floodplain or easements reserved for the maintenance of said surface waters.

Lot, Corner: shall mean a lot which is situated at and abuts the intersection of two or more streets or adjoins a curved street at the end of a block.

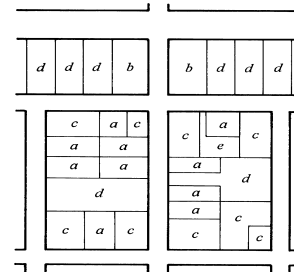

Lots:
 (a) Interior Lot
 (b) Gateway Lot
 (c) Corner Lot
 (d) Double Frontage Lot
 (e) Flag Lot

Lot Coverage: shall mean the percentage of a zoning lot occupied by buildings, including accessory buildings and structures, driveways, sidewalks, decks, and patios.

Lot, Corner: shall mean a lot which has its front and one side yard bordering on a street.

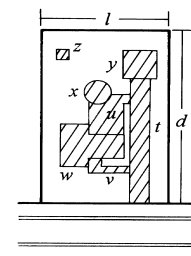

Lot Coverage (m)

$$\text{where } m = \frac{(t + u + v + w + x + y + z)}{\text{area of lot } (l \times d)}$$

Lot Depth: shall mean the distance between the midpoints of the front lot line and the midpoint of the rear lot line.

Lot, Double Frontage: shall mean a lot which has its rear and front yard bordering on a street.

Lot, Flag: shall mean a lot with access provided to the bulk of the lot by a narrow corridor of property and the narrow corridor frontage is the only public street frontage.

Lot, Gateway: shall mean a lot which has its front, rear and one side yard bordering on a street.

Lot, Interior: shall mean a lot which has only its front yard bordering on a street.

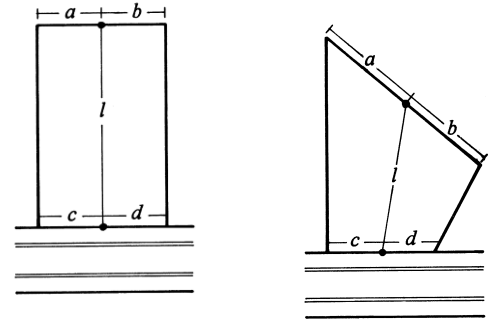

Lot Depth (l): where $a=b$ and $c=d$

Lot Lines: shall mean the lines bounding a lot as defined herein. On a corner lot, the Development Administrator shall designate which of the two lines abutting a street right-of-way shall be considered a corner lot line and which shall be considered a front lot line.

Lot Line, Front: shall mean a street right-of-way forming a boundary of a lot. On a corner lot, the Development Administrator shall designate which of the two lot lines abutting a street right-of-way shall be considered a front lot line and which shall be considered a side lot line.

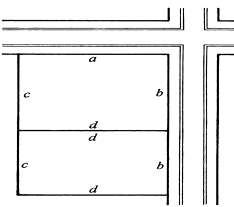

Lot Lines:
 (a) Corner Side Yard Line
 (b) Front Yard Line
 (c) Rear Yard Line
 (d) Side Yard Line

Lot Line, Rear: shall mean a lot-line which is opposite and most distant from the front lot-line and, in the case of irregular, triangular or gore-shaped lots, a line ten feet in length within the lot, parallel to and at the maximum distance from the front lot-line.

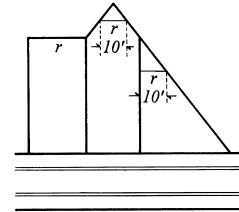

Rear Lot Line (r)

Lot of Record: shall mean a lot which is part of a subdivision the plat of which has been recorded in the office of the DeKalb County Recorder of Deeds.

Lot Line, Side: shall mean any lot boundary line not a front lot line or a rear lot line setback.

Lot Width: shall mean the horizontal distance between the side lot lines of a lot measured within the lot boundary along the front building line.

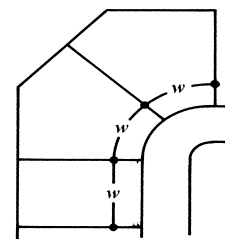

Lot Width (w)

Lot, Zoning: shall mean a designated parcel, tract or area of land within a block established by a plat, subdivision or otherwise permitted by law to be used, developed or built upon as a single unit under single ownership or control. The entire area designated by a shopping center as part of its development shall be considered one (1) zoning lot. The entire area approved as a Planned Development shall be considered one (1) zoning lot.

Lounge: shall mean a room(s) accessory to the principal use of the building or tenant space in the building where alcoholic beverages are served for consumption on the premises and may provide for live entertainment on the premises.

Low Growing Shrubs: shall mean a woody shrub with a maintained or un-maintained average mature height of three (3) feet or less.

Lumber Yard: shall mean an establishment where the principal activity is the retail and wholesale sale of wood products and generally involving outdoor storage of building materials and supplies.

Manufacture: shall mean an economic activity engaged in the mechanical or chemical transformation of materials or substances, including the assembling of component parts, the manufacturing of products and the blending of materials such as lubricating oils, plastics, resins or lacquer, into new products.

Manufactured Home: *A/K/A factory-built house, panelized house, modular home*, shall mean a factory-built residential structure or components thereof which are manufactured or constructed under authority of 42 U.S.C. Section 5403, Federal Manufactured Home Construction and Safety Standards, and is to be used as a place for human habitation, but which is not constructed with a permanent hitch or other device allowing it to be moved other than for purpose of moving to a permanent site and which does not have permanently attached to its body or frame any wheels or axles. A mobile home is not a manufactured home unless it has been converted to real property and is taxed as a site-built dwelling. For the purpose of this Title, a manufactured home shall be considered the same as any site-built residence.

Manufacturing: shall mean the mechanical or chemical transformation of materials or substances into new products including the assembling of components; parts, the manufacturing of products and the blending of materials.

Massing: shall refer to the shape and form a building takes on through architectural design. There are ten (10) architectural design elements which create urban space. A specific project need not incorporate all ten elements: (1) building silhouette—a similar pitch and scale to roof line; (2) spacing between building facades; (3) setback from property line; (4) proportion of windows, bays, and doorways and vertical or horizontal elements tied together in bands across the façade length; (5) proportion of primary façade-size of arcades similar in area and height to width ratios; (6) location and treatment of entryway; (7) materials used in the building's exterior; (8) building scale; (9) landscaping; and, (10) shadow patterns form decorative features with the light and dark surfaces from materials used and projections form window bays and create visual breaks.

Medical Cannabis Cultivation Center: shall mean a facility operated by an organization or business that is registered by the State of Illinois Department of Agriculture to perform necessary activities to provide only registered medical cannabis dispensing organizations with usable medical cannabis. (Ord. 2014-06, 03-18-2014)

Medical Cannabis Dispensary: shall mean a facility operated by an organization or business that is registered by the State of Illinois Department of Financial and Professional Regulation to acquire medical cannabis from a registered cultivation center for the purpose of dispensing cannabis, paraphernalia, or related supplies and educational materials to registered qualifying patients. (Ord. 2014-06, 03-18-2014)

Medical, Dental Clinic: shall mean an establishment where three (3) or more licensed doctors of medicine or dentistry engage in the practice of medicine, operating on a group or individual basis with pooled facilities such as coordinated laboratory, x-ray and allied departments, for the diagnosis and treatment of humans, and may include a drug prescription counter (not a drug store) for dispensing prescription drugs and pharmaceutical products to the patients of said medical or dental clinic.

Mini-Mart, Motor Vehicle: shall mean a gas station which offers or includes as an accessory use, the retail sale of merchandise or services not related to dispensing fuel, the maintenance, service or repair of motor vehicles.

Minimum Contiguous Area: shall mean the area that may constitute a separate or detached part of any zoning district classification as set forth in this Ordinance.

Mobile Home: See Section 4.3.4(K) herein.

Mobile Home Park: See Section 4.3.4(K) herein.

Modular Home: See Manufactured Home.

Motel: shall mean a building offering transient occupancy containing lodging rooms directly accessible from an exterior hall or entrance, providing living, sleeping and sanitary facilities, whether such establishment is designated as a hotel, inn, automobile court, motor inn, motor lodge, tourist court, or otherwise.

Nightclub: shall mean an establishment where alcoholic beverages are served for consumption on the premises and live entertainment is provided. The establishment may provide for dancing and a menu for prepared food items during hours of operation.

Non-Conforming Use: shall mean any building or structure or use of any building or structure or tract of land, lawfully existing or under construction at the time of adoption of this Title or of a later amendment, but does not conform with one (1) or more of the requirements or restrictions of this Title.

Nursery: shall mean a land or structure(s) or a combination used to raise flowers, shrubs, trees, and other plant material for sale.

Nursery School: See **Day Care Center**.

Nursing Home: See **Long Term Care Facility**.

Ornamental Tree: shall mean a tree with an unmaintained average mature height less than twenty (20) feet. Flowers, spring and fall color, and interesting growth habits are characteristics of these trees.

Overlay District: shall mean a set of regulations which add an additional layer of design provisions to an underlying zoning district.

Parking Area, Public: shall mean an open area other than a street or alley, used for the temporary parking of more than four (4) automobiles or commercial vehicles, and available for public use, whether free, for compensation, or as an accommodation for clients, customers or employees.

Patio: shall mean a level, unenclosed surfaced area located at grade and usually directly adjoining or attached to a building.

Personal Wireless Service: See Section 4.4.4(H) herein.

Personal Wireless Service Facility: See Section 4.4.4(H) herein.

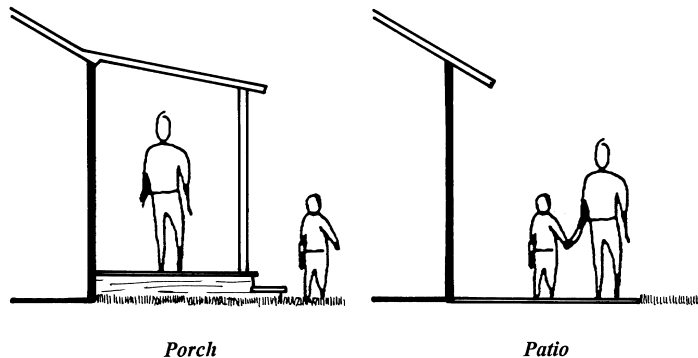

Porch: shall mean a roofed platform projecting from the wall of a building and having direct access to or from the building to which it is attached. A porch has no solid walls other than the wall of the building to which it is attached. A porch may be enclosed with a mesh screen to keep out unwanted insects, but is otherwise exposed to the elements throughout the year.

Porch and Fence: shall mean a building frontage type where the building façade is set back substantially from the frontage line and the porch encroaches in the setback.

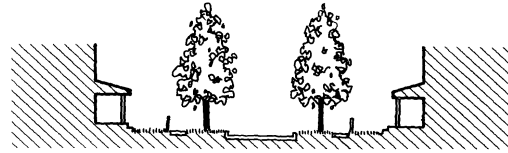

Porch and Fence

Porte-cochere: shall mean a roofed structure open on two (2) or more sides and attached to a building and erected over a driveway for the purpose of temporarily driving a vehicle under to protect occupants when alighting. A *porte-cochere* shall not be construed as a carport.

Property Owners Association: shall mean a private, not-for-profit corporation of property owners that operates and maintains various common properties in a subdivision or development.

Pub: see **Tavern.**

Queuing Space: shall mean the reservoir space occupied by any number of cars that must be accommodated while awaiting ingress or egress to specified business or service establishments.

Recess Line: shall refer to matters of spatial definition and shall mean a line prescribed for the full width of the façade, above which the façade is set back. (Also see, *Transition Line*).

Recreational Vehicle: shall mean any vehicle or boat originally designed for living quarters, recreation, or human habitation and not used as a commercial vehicle, including, but not limited to, the following: (i) *Boats* -- meaning any vessel used for water travel, a boat mounted on a trailer shall be considered one vehicle; (ii) *Camping Trailers* -- meaning a folding or collapsible vehicle without its own motive power, designed as temporary living quarters for travel, camping, recreation or vacation use; (iii) *Motor Homes* -- meaning a temporary dwelling designed and constructed for travel, camping, recreational or vacation use as an integral part of a self-propelled vehicle; (iv) *Off-Road Vehicles* -- meaning vehicles intended primarily for recreational use off of roads where state vehicle licenses are required, e.g. dune buggy, go-cart, snow mobile; (v) *Racing Car/Cycles* -- meaning vehicles intended to be used in racing competition, such as a race car or racing cycle, a racing car/cycle mounted on a trailer shall be considered one vehicle; (vi) *Travel Trailers* -- meaning vehicles without its own motive power, designed to be used as a temporary dwelling for travel, camping, recreational or vacation uses; (vii) *Truck Campers* -- meaning a structure designed primarily to be mounted on a pick-up truck or truck chassis and designed to be used as a temporary dwelling for travel, camping, recreational or vacation uses, when mounted on a truck, such structure shall be considered one vehicle; (viii) *Vans* -- meaning noncommercial motor vehicles licensed by the State of Illinois as a Recreational Vehicle; and (ix) *Vehicle Trailers* -- meaning a vehicle without its own motive power that is designed to transport another vehicle, such as a boat, motorcycle or snowmobile for recreational or vacation use and that is eligible to be licensed or registered and insured for highway use, a vehicle trailer with a vehicle mounted on it shall be considered one vehicle.

Recycling Center: shall mean a facility, that is not a junkyard, in which recoverable resources from used materials and products are purchased, collected, processed to a condition for reuse, or temporarily stored prior to sale to others who will use the recovered resources to manufacture new products.

Recycling Collection Center: shall mean a building or a portion thereof in which recoverable resources from used products and materials are collected and temporarily stored prior to delivery or sale to others who will process the recoverable resources.

Remodel, remodeling: shall mean to remake, redecorate the interior or exterior of a structure without making structural alterations.

Renovation: shall mean to restore to an earlier condition.

Repair Facility, Motor Vehicle: shall mean any building, or portion thereof, used for the repair or replacement of engines, transmissions, differentials, drive trains, or any part thereof, in addition to the replacement of parts, service and incidental repairs to motor vehicles, but excluding operations specified under "motor vehicle body shop."

Restaurant: shall mean any building or part thereof where a menu of food items are cooked and prepared for compensation, for the general public for immediate consumption on and/or off the premises, including any part of such building or part thereof which may be used for dining by the general public. The retail sale of beer, wine and other alcoholic beverages for consumption on the premises and dancing may be provided on the premises. Reheating of already prepared food by microwave and/or the selling of already prepared food for consumption off premises does not constitute a restaurant.

Rest Home: See **Convalescent Home**.

Retention Basin: See Article 6.15 of this Ordinance.

Right-of-Way, Public: shall mean a strip of land dedicated for public use, primarily intended to be occupied or occupied by a road, sidewalk and/or public utility line.

Roadside Stand: shall mean a structure for the display and sale of agricultural products, with no space for customers within the structure.

Rooming House: shall mean a building or portion thereof converting a room or suite of rooms rented as sleeping and living quarters, but without cooking facilities and with or without an individual bathroom for compensation.

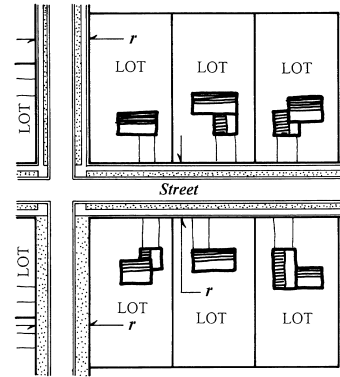

Right-of-Way (ROW) (r)

Sanitarium: See **Hospital**.

Satellite Station: shall mean any disc antenna with an essentially solid surface, whether flat, concave, or parabolic which is designed for receiving television, radio or data electromagnetic or microwave signals from satellites or other satellite stations.

School, Commercial: shall mean a school which principally offers, for profit, specific courses of instruction in business, trade, industry or other trained skills, but does not offer academic instruction equivalent to the standards prescribed by the School Code of Illinois.

School, Private: shall mean an institution conducting regular academic instruction at kindergarten, elementary, junior high and senior high school levels, operated by non-governmental organizations, which programs are accepted by the State of Illinois in lieu of public instruction. This shall not include private commercial schools.

School, Public: shall mean a public institution conducting regular academic instruction at the kindergarten, elementary, junior high and senior high school levels equivalent to the standards prescribed by the School Code of Illinois.

Screen: shall mean a structure or planting composed of sufficient material to obstruct vision beyond the screen. Generally, but not always, a screen is intended to provide in excess of ninety-percent (90%) opaque obstruction to vision during all seasons of the year.

Self-Service Storage Facility: shall mean a building or group of buildings in a controlled access and fenced compound that contains various sizes of individual, compartmentalized, and controlled access stalls or lockers for the storage of customer's goods or wares.

Service Facility, Motor Vehicle: shall mean an establishment where gasoline or other motor fuel, lubricating oil or grease, or fluids for operating or protecting motor vehicles, or accessories to provide added value and convenience to the owner of the vehicle are offered for sale to the public and servicing vehicles with such products is performed on the premises.

Septic System: shall mean an underground system with a septic tank used for the discharge of domestic sewage waste.

Service Station: shall mean a gasoline station, a portion of which is used for the repair or replacement of engines, transmissions, differentials, drive trains or any part thereof, in addition to the replacement of parts, service and incidental repairs to motor vehicles, but excluding operations specified under “motor vehicle body shop.”

Setback: shall refer to matters of spatial definition and shall mean the mandatory distance between a frontage line and a façade, or a lot line and an elevation.

Shade Tree: shall mean a large tree of standard growth habit with an average mature height in excess of twenty (20) feet. The main purpose of this type of tree in landscape designs is to provide shade and scale against buildings.

Shop Front: shall mean a building frontage type where the building façade is aligned directly on the frontage line with the building entrance at grade.

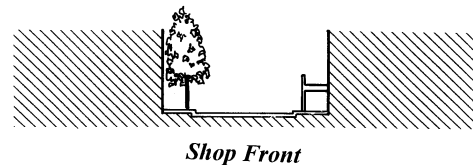

Shopping Center: shall mean a group of more than five (5) business establishments planned, developed and managed as a unit, located on the same lot with off-street parking provided on the property.

Shrub: shall mean a branched woody plant with an unmaintained average mature height less than eight (8) feet.

Sign: shall mean every device, frame, letter, figure, character, mark, plane, point, design, picture, stroke, stripe, trademark, or reading matter, which is used or intended to be used to attract attention or convey information when the same is placed in view of the general public. For the purpose of determining number of signs, a sign shall be considered to be a single display surface or display containing elements organized, related, and composed to form a unit. Where matter is displayed in a random manner without organized relationship to elements, or where there is reasonable doubt as to the relationship of elements, each element shall be considered to be a single sign.

Site, Building: shall mean the ground area of a building or a group of buildings together with all open spaces as required by this Ordinance.

Sight Triangle: shall mean a tri-angular area established on private property at the intersection of two (2) streets or a street and a driveway in which nothing shall be erected, planted, or allowed to grow so as to limit or obstruct the sight distance of motorists and pedestrians. The area between two and one-half (2.5) feet and eight (8) feet above grade is to be free and clear of obstructions.

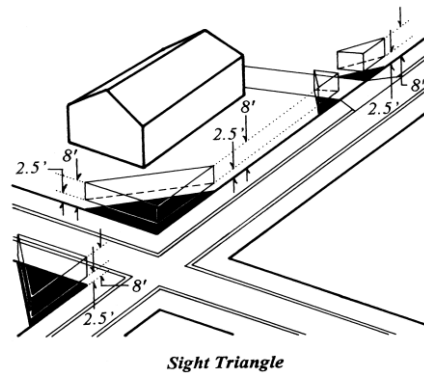

Solar Collector: shall mean (i) An assembly, structure, or design, including passive elements, used for gathering, concentrating, or absorbing direct or indirect solar energy, specially designed for holding a substantial amount of thermal energy and to transfer that energy to a gas, solid, or liquid or to use that

energy directly; or (ii) A mechanism that absorbs solar energy and converts it into electricity; or (iii) A mechanism or process used for gathering solar energy through wind or thermal gradients; or (iv) A component used to transfer thermal energy to a gas solid, or liquid, or to convert it into electricity.

Solar Energy: shall mean radiant energy received from the sun at wavelengths suitable for heat transfer, photosynthetic use, or photovoltaic use.

Solar Energy System: shall mean (i) a complete assembly, structure, or design of a solar collector, or a solar mechanism, which uses solar energy for generating electricity or for heating or cooling gases, solids, liquids, or other materials; (ii) the design, materials, or elements of a system and its maintenance, operation, and labor systems designed or constructed to interface with a solar energy system; and, (iii) any legal, financial, or institutional orders, certificates, or mechanisms, including easements, leases, and agreements, required to ensure continued access to solar energy, its source, or its use in a solar energy system, and including monitoring and educational elements of a demonstration project. Solar Energy System does not include (i) Distribution equipment that is equally usable in a conventional energy system except for such components of such equipment as are necessary for meeting the requirements of efficient solar energy utilization; (ii) Components of a solar energy system that serve structural, insulating, protective, shading, aesthetic, or other non-solar energy utilization purposes, as defined in the regulations of the Department; and, (iii) Any facilities of a public utility used to transmit or distribute gas or electricity.

Solar Storage Mechanism: shall mean equipment or elements (such as piping and transfer mechanisms, containers, heat exchangers, or controls thereof, and gases, solids, liquids, or combinations thereof) that are utilized for storing solar energy, gathered by a solar collector, for subsequent use.

State: shall mean the State of Illinois.

Stoop: shall mean a building frontage type where the building façade is aligned directly on the frontage line with the ground floor elevated to provide secure privacy at the windows.

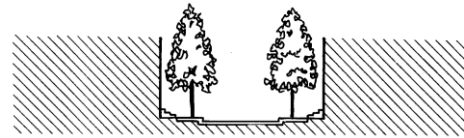

Stoop

Stormwater: See Article 6.15 of this Ordinance.

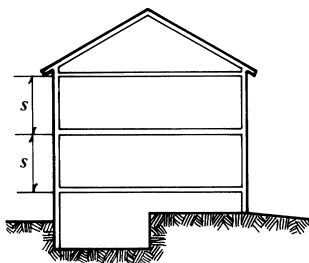

Story (s)

Story: shall mean that portion of a building included between the surface of the floor next above; or if there is no floor above, the space between the floor

Street: shall mean the paved or unpaved portion of a public or private right-of-way, other than an alley which affords principal means of vehicular access to abutting property.

Street, Local: shall mean a street of limited continuity used primarily for access to abutting properties and designated "Non-Arterial" by the Public Works Director.

Street Tree: shall mean a tree of standard growth habit acceptable to the City of Genoa for installing within the public right-of-way.

Street Orientation: shall mean the direction of the architectural front façade of a building in relation to the street.

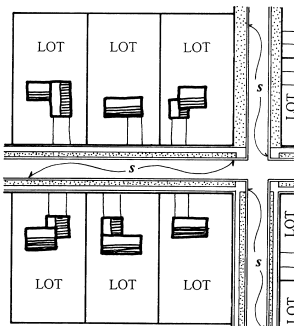

Street (s)

Structural Alteration: shall mean any change or modification, other than incidental repairs or which are required by provisions of this Ordinance, which would prolong the life of the supporting member of a structure such as bearing walls, columns, beams, girders or foundations.

Structure: shall mean anything erected, the use of which requires more or less permanent location on or in the ground or attached to something having a permanent location on or in the ground, including, for example, buildings, towers, antennae, freestanding signs, decks, garden sheds and swimming pools.

Supportive Living Facility: shall mean a residential setting that provides or coordinates flexible personal care services, twenty-four (24) hour supervision and assistance (scheduled and unscheduled), activities, and health related services with a service program and physical environment designed to minimize the need for residents to move within or from the setting to accommodate changing needs and preferences; has an organizational mission, service programs and a physical environment designed to maximize residents' dignity, autonomy, privacy and independence; and encourages family and community involvement.

Swimming Pool: shall mean a structure designed to hold water and maintain a water depth of twenty-four (24) inches or more, but not including hot tubs or wading pools.

Tavern: shall mean an establishment for the retail sale of beer, wine and other alcoholic beverages for consumption on the premises and providing a menu of food items prepared during all hours of operation. The incidental sale of packaged liquor may be provided during the hours of operation. Dancing may be permitted on the premises.

Terminal, Bus or Train: shall mean a building or area specifically designated for the assembly and boarding and unboarding of passengers to/from a train or bus.

Terminal, Motor Freight: shall mean a building or an area in which freight brought by truck is assembled and/or temporarily stored for routing or reshipment, or in which semi-trailers, including tractor and/or trailer units and other trucks, are parked or stored.

Terrace: shall mean a landscape treatment of mounded earth, rock wall, railroad tie wall or other retaining device used to modify steep grade differences on a lot. A terrace shall not include a patio or deck surface.

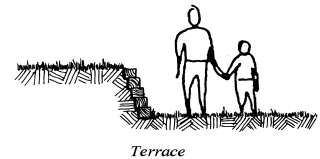

Tract: is used interchangeably with the term "lot", particularly in the context of subdivisions, where one "tract" is subdivided into several "lots".

Trailer: shall mean any structure built on a chassis for licensing by the Secretary of State as a trailer and designed for general hauling or recreational purposes.

Transition Line: shall refer to matters of spatial definition and shall mean a line prescribed for the full width of the façade, expressed by a variation in of material or by a limited projection such as a cornice or a balcony.

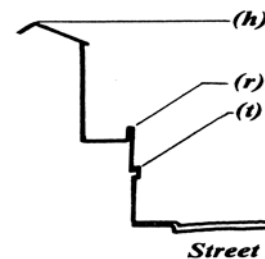

Transition Line (t)
Building Height (h)
Recess Line (r)

Tree Survey: shall mean a scaled drawing accurately locating and indicating the size, condition and specie (common and botanical names) of all trees having a caliper of four (4) inches or larger, and the location of any buildings, parking areas, sidewalks and streets on a parcel of property.

Use: shall mean the purpose or purposes for which land, buildings or structures is (are) designed, arranged or intended, or for which they are or may be occupied or maintained.

Variation: shall mean a modification of the application of this Title in specific cases where practical difficulties or particular hardships, not intended or not common to other property owners in the district, would result from following the strict letter of the Title.

Wall, Common: shall mean an interior wall that separates and distinguishes two (2) or more uses located in the same building or structure. A common wall extends from floor to ceiling and from exterior wall to exterior wall, and conforms to the fire resistance requirements of the City's Building Code.

Warehouse: shall mean a structure, or part thereof, or area used principally for the storage of goods and merchandise.

Warehouse and Distribution Center: shall mean a building used in the storage, wholesale, and distribution of manufactured products, supplies, and equipment, but excluding bulk storage of materials that are flammable or explosive or that create hazardous or commonly recognized offensive conditions.

Wholesale Establishment: shall mean a business establishment principally engaged in selling to retailers or distributors rather than consumers.

Wireless Communication Facility: See Section 4.3.4(H) herein.

Wrecking Yard, Vehicle: shall mean a lot or any portion of a lot where two (2) or more motor vehicles or trailers which, for a period of thirty (30) days, have not been capable of operating under their own power, and from which parts have been or are to be removed for sale or reuse, or any land, buildings, or structures used for the wrecking, dismantling, salvage, sale or storage of such motor vehicles, trailers or the parts thereof.

Yard: shall mean an open space on a lot which is unoccupied and unobstructed from its lowest level to the sky, except for permitted yard obstructions, and which extends along a lot line and at right angles or radial thereto to a depth or width specified in the yard regulations for the district in which the zoning lot is located.

Yard, Corner Side: shall mean a yard extending the full length of a corner side lot line and back to a line drawn parallel to the corner side lot line at a distance equal to the required corner side yard depth.

Yard, Front: shall mean a yard extending along the full length of a front lot line and back to a line drawn parallel to the front lot line at a distance equal to the required front yard depth.

Yard, Rear: shall mean a yard extending along the full length of a rear lot line and back to a line drawn parallel to the rear lot line at a distance therefrom equal to the required rear yard depth, but excluding any area encompassed within a required corner side yard.

Yard, Side: shall mean a yard extending along the full length of a side lot line and back to a line drawn parallel to the side lot line at a distance equal to the required side yard, depth, but excluding any area encompassed within a required front yard or rear yard.

Yard, Transition: shall mean the required front, side, corner side or rear yard on a lot in a commercial or industrial district and an adjoining residential district, or the required front, side, corner side or rear yard for a

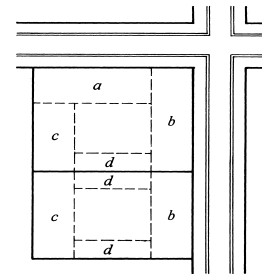

Yards:
 (a) Corner Side Yard
 (b) Front Yard
 (c) Rear Yard
 (d) Side Yard

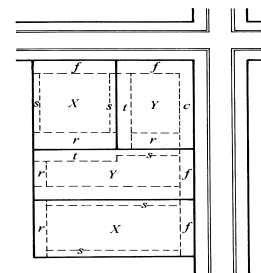

Transition Yards (T)

non-residential use and adjoining residential uses in a residential district, except when such yard is adjacent a railroad right-of-way, alley or street.

Zone: See **District, Zoning.**